

Characteristics / Ordering Code

The pressure relief valve series VS is a direct operated spool valve for subplate mounting. The connection and function is according to ISO 6264.

Function

- Spool type valve
- Subplate mounting according to ISO 6264
- 5 pressure stages
- 2 adjustment modes
- Gauge port

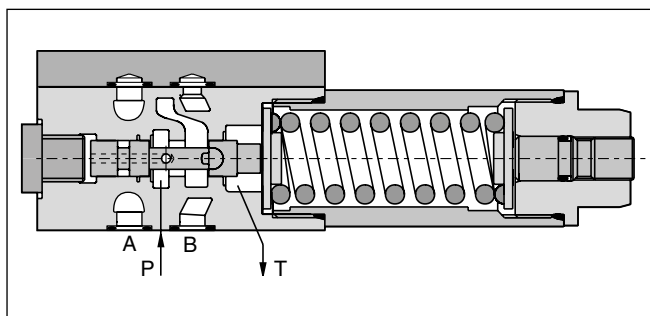
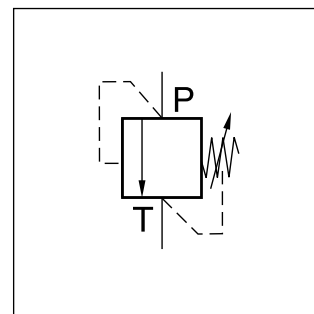

4

Ordering code

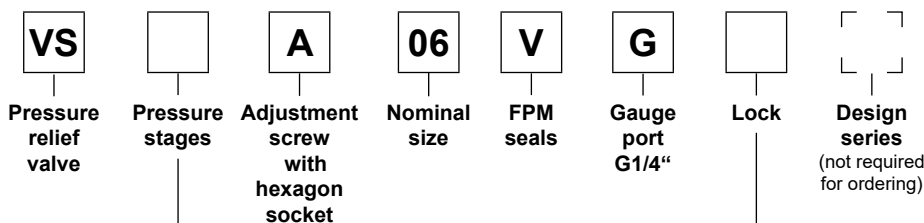

Code	Pressure stages
025	up to 25 bar
064	up to 64 bar
160	up to 160 bar
210	up to 210 bar
350	up to 350 bar

Code	Lock
omit	-
Z	Cylinder lock

Bold letters = Short-term availability

Technical data

General		
Design		Direct operated relief valve spool type
Nominal size		DIN NG06 / CETOP 03 / NFPA D03
Interface		Subplate mounting according to ISO 6264
Mounting position		unrestricted
Ambient temperature	[°C]	-20...+60
MTTF _D value	[years]	150
Weight	[kg]	1.3
Hydraulic		
Max. operating pressure	[bar]	Port P 350, Port T depressurized
Pressure stages	[bar]	25, 64, 160, 210, 350
Nominal flow	[l/min]	25
Fluid		Hydraulic oil according to DIN 51524
Fluid temperature	[°C]	-20...+70
Viscosity permitted	[cSt] / [mm ² /s]	20...400
recommended	[cSt] / [mm ² /s]	30...80
Filtration		ISO 4406 (1999); 18/16/13

p/Q performance curves

Pressure stage 25 bar

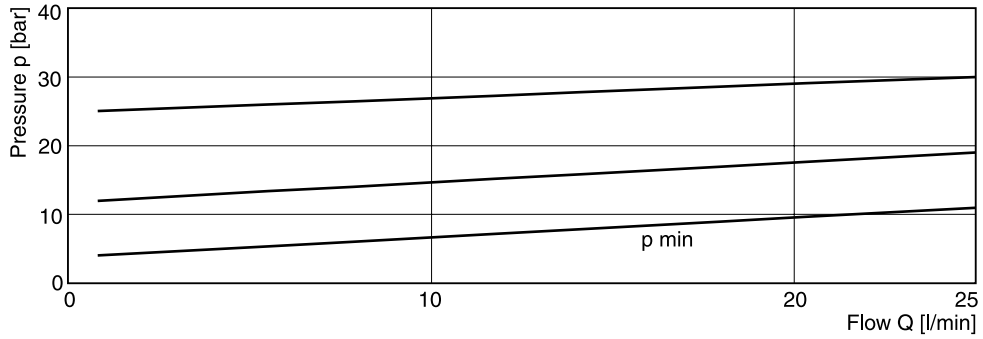

Pressure stage 64 bar

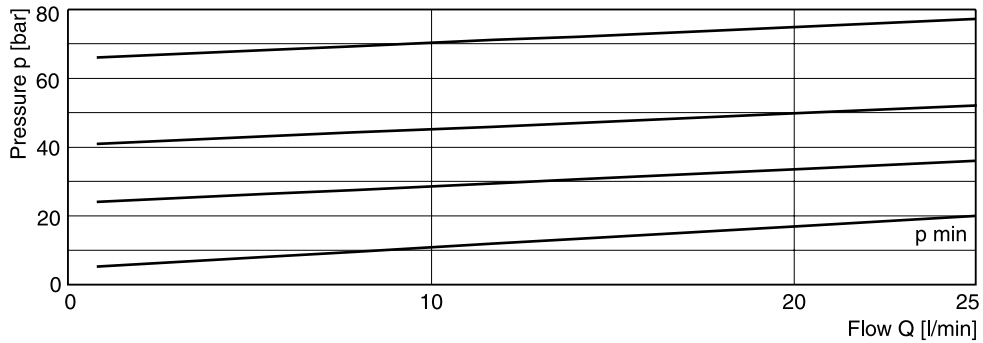



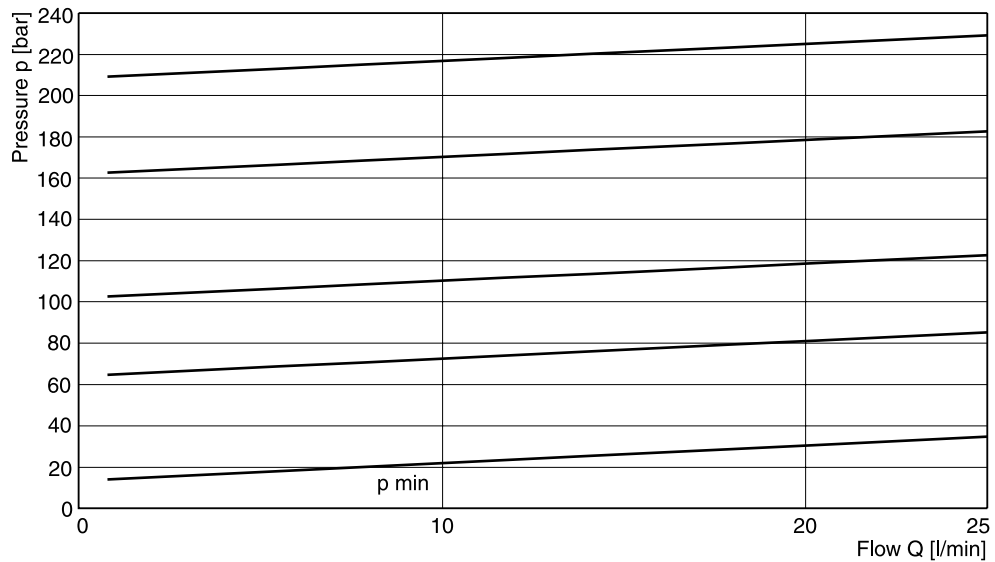

Pressure stage 160, 210 and 350 bar

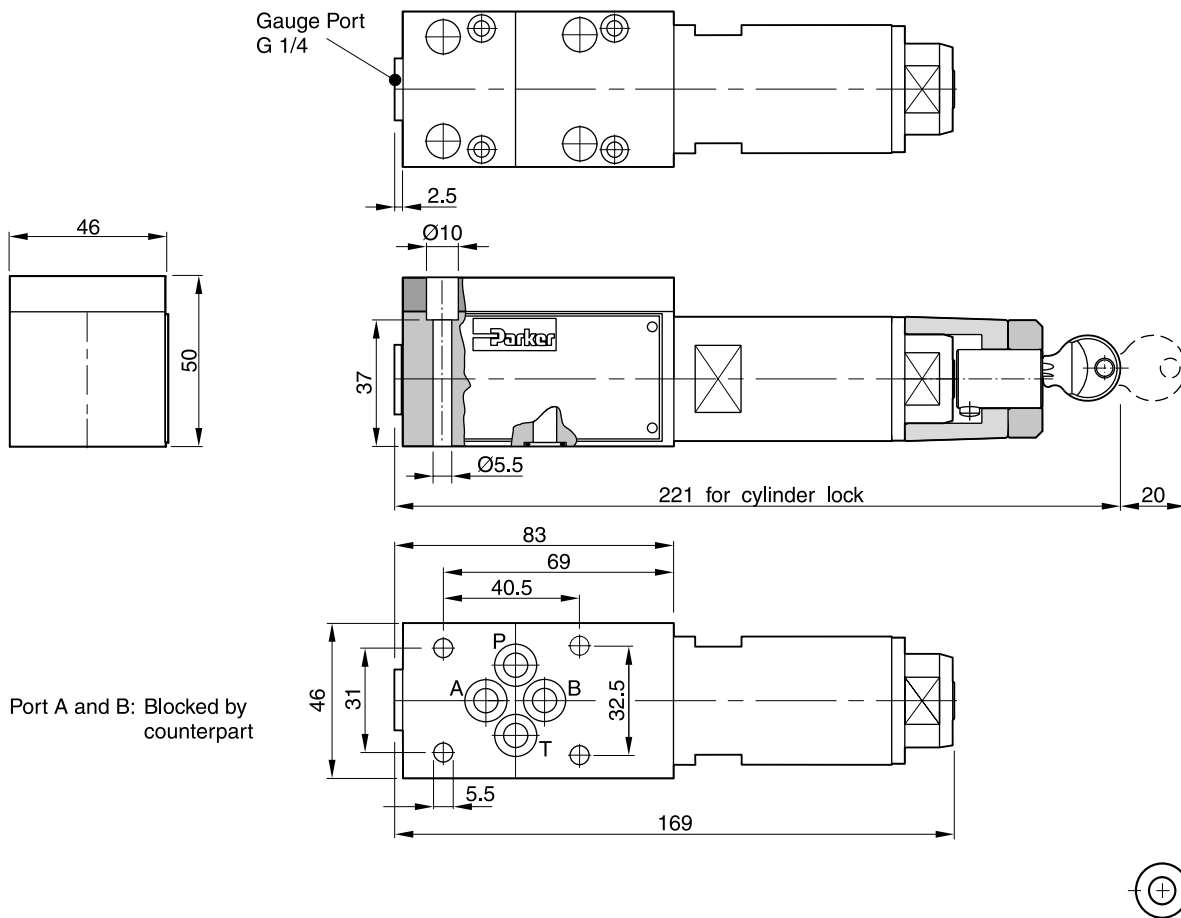

All characteristic curves measured with HLP46 at 50 °C.

4

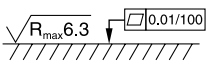

Surface finish	Bolt kit			 Kit FPM
	BK443	4x M5x45 ISO 4762-12.9	7.6 Nm ±15 %	SK-VB/VM/VS-A06V

Mounting pattern ISO 6264, code 6264-03-04-*-97

